

# Data Sheet

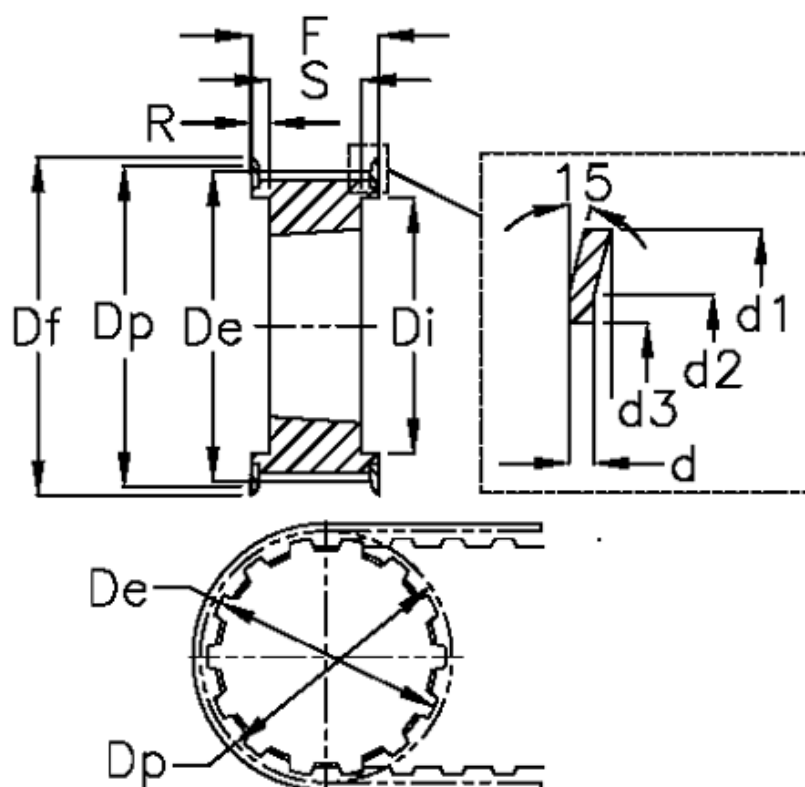

Article number: 604133048055  
 Description: Taper bored timing belt pulley  
 HTD 48 14M 55 TL 3020

## Measures



$d = 2.5$	F = 70	Weight = 10.4
$d1 = 226$	Flange type = F62	Width = 55
$d2 = 214$	For bushing = 3020	
$d3 = 190$	Max bore = 75	
$De = 211.11$	r = 9.5	
$Df = 226$	S = 51	
$Di = 170$	Tooth number = 48	
$Dp = 213.9$	Type = 14M	